

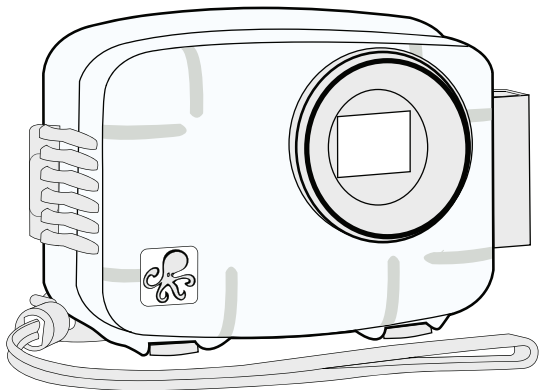

Digital Housing

Supplemental Instructions

6282.12 Nikon S1200pj



Size and Weight

Width6.2 in. (157mm) including controls

Height4.4 in. (112mm) including controls

Depth.....3.6 in. (91mm) including controls & lens port

Weight1 lb. (454g)





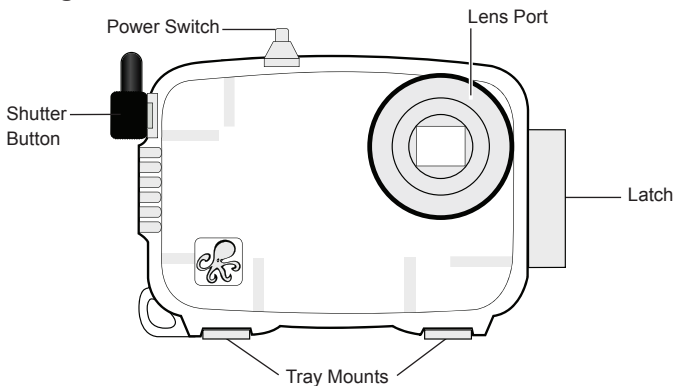



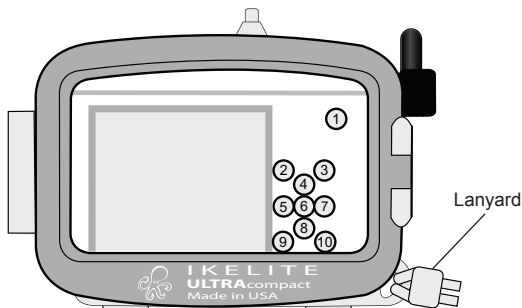

Buoyancy.....Slightly positive in fresh water

Housing Controls - Front View



Back View



- | | |
|---|---|
| 1. Movie-record Button  | 6. OK / Apply Selection  |
| 2. Shooting Mode Button  | 7. Exp. Comp.  |
| 3. Playback Button  | 8. Macro Mode  |
| 4. Flash Mode  | 9. Menu Button  |
| 5. Self-timer,  | 10. Delete Button  |



Housing Zoom Control

The Housing Zoom Control fork must be in the “up” starting position before placing camera in the housing.



Correct Zoom Control
Starting Position

Initial Camera Settings

- Set Time Zone and Date.
- Set to Auto Mode .
- Set ISO sensitivity to 80.
- Set Image Mode to “14m.”
- Set White Balance to “Auto.”
- Set Flash mode to forced “ON” .
- Set metering to “Center-Weighted.”
- Set Autofocus mode to “Single AF” and AF area mode to “Center.”
- Set AF assist to “Off.”

Notes: Enable Macro  mode when shooting close-up subjects. If overexposure occurs, back away from the subject and zoom in.

- A strobe focusing light is recommended to assist autofocus.

External Accessory Lenses

An external wide angle conversion lens increases angle of coverage so you can get much closer to your subject while still fitting everything in the frame. By reducing the amount of water between the subject and your camera lens, the resulting image will be more crisp and colorful.

Attach 67mm threaded 6420 Ikelite W-20, Inon Type II and Epoque lenses using the 9306.78 port adapter. This adapter may also be used to attach 67mm threaded macro lenses. Attach bayonet style Inon macro or UWL-100 28AD, UWL-105AD and UFL-165AD wide angle or macro lenses using the 9306.85 port adapter.

Moderate vignetting (shading in the corners) will be present in the widest setting when using an external accessory lens. This effect can be minimized by zooming in slightly.

AF35 Strobe Package 4035

The AutoFlash AF35 kit is a great compliment, and an effortless, affordable way to add a flash to your new Ikelite point and shoot camera system. Everything you need to get started is in the box. Just attach it to the bottom of your housing and start taking pictures!

AF35 AutoFlash kit includes:

AF35 strobe - Flex arm - AutoFlash sensor
Handle with rubber grip - Tray (single or dual)
Mounting hardware.

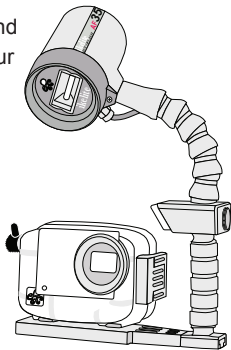

A full range of accessories is available to support your housing. Please visit http://www.ikelite.com/web_two/nik_s1200.html to see the most current information about recommended accessories for your housing.

Ikelite Technical Support

E-mail: ikelite@ikelite.com

Phone 317.923.4523

Fax 317.924.7988



Ikelite Underwater Systems
50 West 33rd Street
Indianapolis, IN 46208 USA